

Elektroherde
Готварска печка
Cooker
Pećnica

HMS 81120

Gebrauchsanleitung

Blomberg

Please read this manual first.

Dear Customer,

We would like you to obtain best performance with your product that has been manufactured in modern facilities and passed through strict quality control procedures.

Therefore, we advise you to read through this User Manual carefully before using your product and keep it for future reference. If you hand over the product to someone else, deliver the User Manual as well.

The User Manual will help you use the product in a fast and safe way.

- Read the User Manual before installing and starting the product.
- You must strictly observe the safety instructions.
- Keep this User Manual within easy reach for future reference.
- Also read other documents supplied with the product.
Remember that this User Manual may also be applicable for several other models.
Differences between models are explicitly identified in the manual.

Explanation of symbols

Throughout this User Manual the following symbols are used:

 Important information or useful hints about usage.

 Warning for hazardous situations with regard to life and property.

 Warning for electric shock.

 Warning for risk of fire.

 Warning for hot surfaces.

Table of Contents

1	General information	4
	Overview	4
	Technical Data	5
	Accessories supplied with the unit	6
2	Safety instructions	7
	Basic safety instructions.....	7
	Safety when working with electricity	8
	Intended use	8
	Safety for children	8
3	Installation	9
	Before installation	9
	Installation and connection.....	9
	Disposal	11
	Disposing of packaging material	11
	Old equipment.....	11
	Future transportation.....	11
4	Preparation	12
	Tips for saving energy	12
	Initial operation	12
	First cleaning of the appliance	12
	Initial heating	13
5	How to use the hob	14
	General information on cooking.....	14
	How to use hobs.....	14
6	How to operate the oven	16
	General information on baking, roasting and grilling	16
	How to use the electric oven	16
	Operating modes.....	17
	How to operate the oven timer.....	18
	Cooking times table.....	18
	How to operate the grill	19
	Cooking times table for grilling.....	19
7	Maintenance and care	20
	General information	20
	How to clean the hob.....	20
	Cleaning the control panel	20
	Cleaning the oven	20
	Removal of oven door.....	20
	Replacing the oven lamp	21
8	Troubleshooting	22

1 General information

Overview

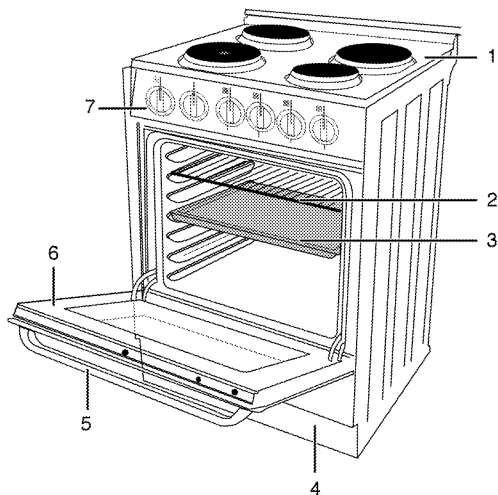
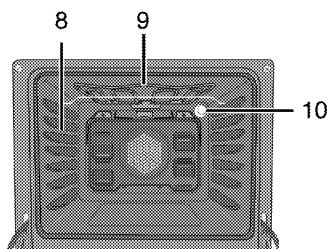

- | | | | |
|---|----------------|----|-----------------------|
| 1 | Burners' plate | 6 | Front door |
| 2 | Wire shelf | 7 | Control panel |
| 3 | Tray | 8 | Shelf positions |
| 4 | Bottom drawer | 9 | Grill heating element |
| 5 | Handle | 10 | Lamp |

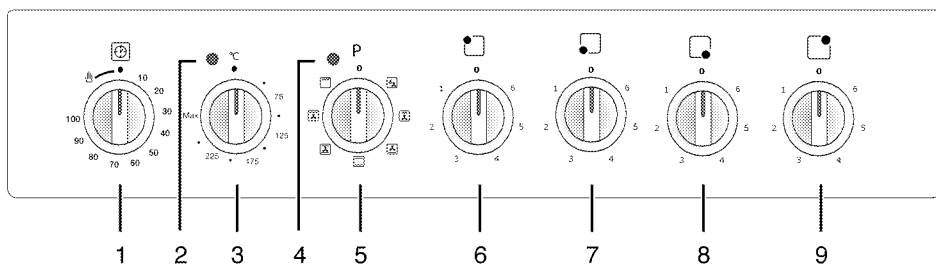

- | | | | |
|---|------------------|---|----------------------|
| 1 | Mechanical timer | 6 | Hotplate Rear left |
| 2 | Thermostat lamp | 7 | Hotplate Front left |
| 3 | Thermostat knob | 8 | Hotplate Front right |
| 4 | Warning lamp | 9 | Hotplate Rear right |
| 5 | Function knob | | |

Technical Data

GENERAL	
Outer dimensions (height/width/depth)	850 mm/500 mm/600 mm
Voltage/frequency	220-230V ~/380-400 V 3N ~ 50 Hz
Total electric consumption	7.5 kW
Fuse protection	min. 16 A x 3 / 32 A
Cable type / cross section	H05VV-FG 5 x 1.5 mm ² / 3 x 2,5 mm ²
Cable length	max. 2 m
HOB	
Burners	
Rear left	Hotplate
Size	145 mm
Power	1000 W
Front left	Hotplate
Size	180 mm
Power	2000 W
Front right	Hotplate
Size	145 mm
Power	1000 W
Rear right	Hotplate
Size	180 mm
Power	1500 W
OVEN/GRILL	
Main oven	Multifunction oven
Energy efficiency class [#]	A
Inside illumination	15–25 W
Grill power consumption	1.6 kW

[#] Basis: In electrical ovens, the data on energy labels are in conformity with EN 50304. Values were determined under standard load and convection/hot air (if available). Heating mode with an energy efficiency rating specified by EN 50304 is determined in accordance with below priority order depending on functions (modes) availability on the product. 1- Eco fan heating, 2-Slow cooking, 3-Fan heating (hot air), 4-Top and bottom heat with convection air, 5-Top and bottom heating.

Accessories supplied with the unit

 Accessories supplied can vary depending on the product model. All the accessories described in the user manual may not exist on your product.

Baking tray

Can be used for pastries, frozen foods and big roasts.

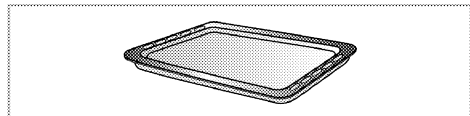

Deep roasting tray

Can be used for pastries, big roasts, foods with liquid content and during grilling as dripping pan.

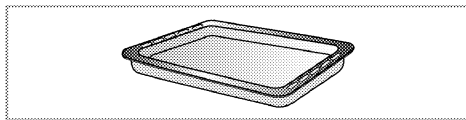

Wire shelf

Can be used for roasting and as deposit for baking, roasting and casserole dishes.

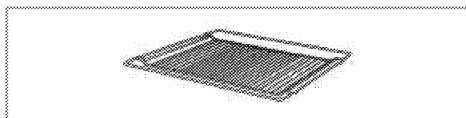

2 Safety instructions

Basic safety instructions

- The manufacturer reserves its right to make changes in the technical specifications in order to improve the appliance quality without any prior notice. Figures included in this manual are for schematic purpose only and may not match exactly with your appliance. Values stated on the markings of the appliance or in other printed documents supplied with the appliance are obtained under laboratory conditions as per relevant standards. These values may vary according to the usage of the appliance and ambient conditions.
- This appliance is not intended for use by persons (including children) with reduced physical, sensory or mental capabilities, or lack of experience and knowledge, unless they have been given supervision or instruction concerning use of appliance by a person responsible for their safety.
Children should be supervised to ensure that they do not play with the appliance.
- "An additional protective means to avoid contact with the oven door is available. This part should be fitted when young children are likely to be present."
- Never use when judgement or coordination is impaired by the use of alcohol and/or drugs.
- Do not operate the appliance if it is defective or shows any visible damage.
- Do not carry out any repairs or modifications on the appliance. However, you may remedy some malfunctions; see *Troubleshooting*, page 22.
- Be careful when using alcoholic drinks in your dishes. Alcohol evaporates in high temperatures and may catch fire when it comes in contact with hot surfaces.
- Do not heat closed food containers and glass jars. Pressure that may build-up in the jar can cause it to burst.
- Ensure that no flammable materials are adjacent to the appliance as the sides become hot during use.
- Do not leave empty pots or pans on plates that are switched on. They may get damaged.
- Since it may be hot, do not leave plastic or aluminum dishes on the surface of appliance. These kind of dishes should not be used to keep food either.
- Do not place baking trays, dishes or aluminium foil directly onto the bottom of the oven. The heat accumulation might damage the bottom of the oven. Keep all ventilation slots clear of obstructions.
- Appliance may be hot when it is in use. Never touch the hot burners, inner sections of the oven, heating elements etc. Keep children away!

- Always use heat-resistant gloves when putting or removing the dishes into/from your oven.
- Don't use the cooker with front door glass removed.
- Rear surface of the oven gets hot when it is in use. Gas / Electric connection should not touch the rear surface, otherwise the mains cable may get damaged. Do not trap the mains cable between the hot oven door and frame. Do not route the mains cable over the hot cooking section. Otherwise, cable insulation may melt and cause fire as a result of short circuit.
- Check all controls on the appliance are switched off after use.

 For the warranty to be valid, the appliance must be installed by a qualified person in accordance with current regulations.

Safety when working with electricity

- Any work on electric equipment and systems may only be carried out by authorized qualified persons.
- In case of any damage, switch off the appliance and disconnect it from the mains supply by removing the fuse or switching off the circuit breaker.
- Ensure that the fuse rating is correct.

Intended use

This product is designed for domestic use. Commercial use is not admissible. This product should not be used for warming the plates under the grill, drying towels, dish cloths and etc. by hanging them on the handles and for heating purposes.

The manufacturer shall not be liable for any damage caused by improper use or handling.

The oven can be used for defrosting, baking, roasting and grilling food.

Safety for children

- Accessible parts of the appliance will become hot whilst the appliance is in use and until the appliance has cooled, children should be kept away.
- Accessible parts may be hot when the grill is in use. Young children should be kept away.
- Do not store any items above the appliance that children may reach.
- The packaging materials will be dangerous for children. Keep the packaging materials away from children. Please dispose of all parts of the packaging according to environmental standards.
- When the door is open, do **not** load any heavy object on it and do **not** allow children to sit on it. It may overturn or door hinges may get damaged.

3 Installation

Before installation

To ensure that critical air gaps are maintained under the appliance, we recommend that this appliance is mounted on a solid base and that the feet do not sink into any carpet or soft flooring.

The kitchen floor must be able to carry the weight of the appliance plus the additional weight of cookware and bakeware and food.

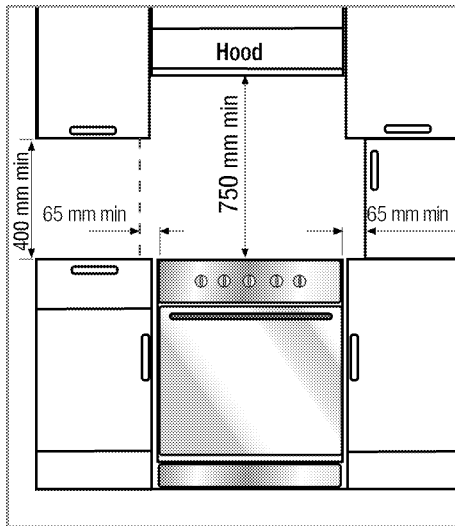



A safety distance must be left between the appliance and the kitchen walls and furniture. See figure (values in mm).

- It can be used with cabinets on either side but in order to have a minimum distance of 400mm above hotplate level allow a side clearance of 65mm between the appliance and any wall, partition or tall cupboard.
- It can also be used in a free standing position. Allow a minimum distance of 750mm from the hob surface to adjacent

surfaces above the hob surface and 600mm to a cabinet above.

- If a appliance hood is to be fitted, refer to the manufacturer's instructions regarding fixing height.
- The appliance corresponds to device class 1, i.e. it may be placed with the rear and **one** side to kitchen walls, kitchen furniture or equipment of any size. The kitchen furniture or equipment on the **other** side may only be of the same size or smaller.
- Any kitchen furniture next to the appliance must be heat-resistant (100 °C min.).

Installation and connection

-  Do not install the appliance next to refrigerators or freezers. The heat emitted by the appliance will lead to an increased energy consumption of cooling appliances.
- Appliance to be installed in accordance with the local authority requirements for gas, electricity and any other authority having jurisdiction.
- Carry the appliance with at least two persons.
-  **Material damage!**
The door and/or handle must not be used for lifting or moving the appliance.
- The appliance must be placed directly on the floor. It must not be placed onto a base or a pedestal.

-  Risk of explosion by damage of the safety tube!
The safety tube must not be clamped, bent or trapped or come into contact with hot parts of the appliance.

Connection to the mains supply

 **This appliance must be earthed!**

Our company shall not held responsible for any damage caused by using the appliance without earthed socket.

-  Risk of electric shock, short circuit or fire by unprofessional installation!
The appliance may be connected to the mains supply only by an authorized qualified person and the appliance is only guaranteed after correct installation.

-  Risk of electric shock, short circuit or fire by damage of the mains lead!
The mains lead must not be clamped, bent or trapped or come into contact with hot parts of the appliance.
If the mains lead is damaged, it must be replaced by a qualified electrician.

The mains supply data must correspond to the data specified on the rating plate of the appliance. The rating plate is either seen when the door or the lower cover is opened or it is located at the rear wall of the appliance depending on the appliance type.

The supply cable of the appliance must correspond to the specifications;

see technical data table *Technical Data*, page 5.

-  Risk of electric shock!
Before starting any work on the electrical installation, please disconnect the appliance from the mains supply.

1. A mains lead is not supplied with the appliance, It must connect a mains lead to your appliance that you would select from the table on basis of the installation at your home, following the instructions in the wiring diagram.

If no all-pole separation from the mains supply is possible, a separation appliance must be connected with a contact distance of 3 mm min. (fuses, line safety switches, contactors) all poles which should be adjacent to (but not above) the appliance in accordance with IEE regulation. Failure to observe this instruction may result in operational problems and invalidation of the appliance warranty. Additional protection by a residual current circuit breaker is recommended.

2. Open the terminal block cover with screwdriver.
3. Pass the mains lead through the cable clamp under the terminal and fix the mains lead to main body with supplied screw via cable tightener.
4. Connect the cables according to the supplied diagram.
5. Close the cover of the terminal block once the wiring is complete.

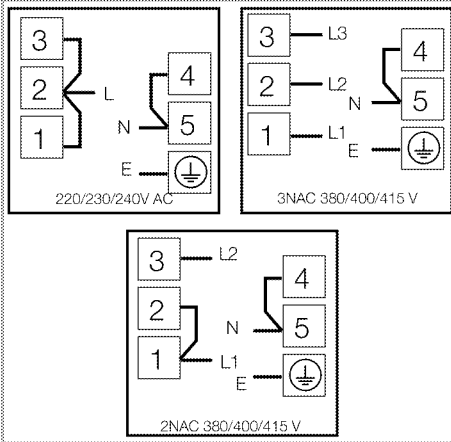

i Mains lead must not be longer than 2 metres for safety reasons.

6. The mains lead should be routed away from the appliance and not be trapped between the appliance and the wall.
 - Position appliance up to the kitchen wall.
 - To align the appliance with the worktop, adjust the feet turning right or left hand as required.

Final check

1. Switch electricity supply on.
2. Check electrical functions.

Disposal

Disposing of packaging material

Packaging materials are dangerous to children. Keep packaging materials in a safe place out of reach of children. Packaging materials of the product are manufactured from recyclable materials. Dispose of them properly and sort in accordance with recycled waste instructions. Do not dispose of them with normal domestic waste.

Old equipment



This appliance bears the selective sorting symbol for waste electrical and electronic equipment (WEEE). This means that this appliance must be handled pursuant to European Directive 2002/96/EC in order to be recycled or dismantled to minimize its impact on the environment. For further information, please contact your local or regional authorities.

Electronic appliances not included in the selective sorting process are potentially dangerous for the environment and human health due to the presence of hazardous substances.

Future transportation

- i** Do not place other items on the top of the appliance. The appliance must be transported upright.

Store the appliance's original box and transport the appliance in its original carton. Follow the guidance marks that are printed on the carton.

- i** Verify the general appearance of your equipment by identifying possible damage during the transportation.

To prevent the wire shelf and tray inside the oven from damaging the oven door, place a strip of cardboard onto the inside of the oven door that lines up with the position of the trays. Tape the oven door to the side walls.

If you do not have the original carton

Pack the appliance in bubble wrap or thick cardboard and tape it securely in order to prevent damage during transportation.

4 Preparation

Tips for saving energy

The following tips will help you to use your appliance in an ecological way and to save energy:

- Use dark coloured and enamel coated trays, since the heat transmission will be better.
- While cooking your meals, perform a preheating operation if it is advised in the user manual or cooking instructions.
- During cooking, do not open the oven door frequently.
- Try to cook more than one type of meal within the oven at the same time (You can cook two different meals at the same time by locating cooking bowls on the same shelf). It will be suitable to cook more than one meal after each other. The oven will already be hot.
- Defrost frozen meals before cooking them.
- You can save energy by switching off your oven a few minutes before the end of the cooking time (The oven door should not be opened).
- Use pots/pans with lids for cooking. Without a lid, the energy consumption may be up to four times higher.
- Choose the burner/plate which is suitable to the saucepan base. Always choose the correct size of saucepans for your meals. For larger burners/plates more energy is needed.

- Take care to use flat base saucepans while cooking on electrical cookers. Pots with an even and thick bottom provide better thermal conduction. You can save up to 1/3 of electricity.
- Pots and pans should match the size of plates. The bottom of the pot or pan should not be smaller than the plate.
- Keep plates and pan bottoms clean. Dirt will reduce the heat transmission between plate and pan bottoms.
- In case of longer cooking times, switch off the plate 5 to 10 minutes before the end of the cooking time. When you use the residual heat, you can save up to 20 % of electricity.

Initial operation

First cleaning of the appliance

 The surface may get damaged by some detergents or cleaning materials.

Do not use aggressive detergents, cleaning powder/cream or any sharp objects.

1. Remove all packaging materials.
2. Wipe the surfaces of the appliance with a damp cloth or sponge and dry with a cloth.

Initial heating

 Hot surfaces may cause burns! Do not touch the hot surfaces of the appliance. Use oven gloves. Keep children away from the appliance.

 Smell and smoke may emit during first heating. Ensure that the room is well ventilated.

Any production residues or conservation layers must be burnt off before the first use. Heat up the appliance for about 30 minutes and then switch it off.

Electric oven

1. Take all baking trays and racks from the oven.
2. Close oven door.
3. Select top and bottom heat with the function knob.
4. Select the highest temperature with the thermostat knob; see *How to use the electric oven, page 16*.

5. Heat approximately 30 minutes.
6. Switch off oven; see *How to use the electric oven, page 16*

Grill oven

1. Take all baking trays and wire shelf from the oven.
 2. Close oven door.
 3. Select highest power of the grill; see *How to operate the grill, page 19*.
 4. Heat approximately 30 minutes.
 5. Switch off grill; see *How to operate the grill, page 19*
1. Any production residues or conservation layers must be burnt off before the first use. Adjust the hotplate to mid position and leave on for about 8 minutes. Do not place any pans or other cooking utensil on the hotplate during this process.

5 How to use the hob

General information on cooking

⚠ Risk of fire by overheated oil!
When you heat oil, do not leave it unattended.

Never try to extinguish the fire with water! When oil has caught fire, immediately cover the pot or pan with a lid. Switch off the hob if safe to do so and phone the fire service.

- Ensure handles of pans cannot accidentally be caught or knocked and do not get hot by adjacent heating zones. Avoid pans that are unstable and easily tipped. Pans that are too heavy to move easily when filled can also be a hazard. Only use flat bottomed pots or pans.
- Use pans which have sufficient capacity for the amount of food being cooked so they don't boil over and cause unnecessary cleaning.
Do not place lids on the burners. Always position pans centrally over the burners. When transferring pans from one burner to another always lift the pans do not slide them.

How to use hobs

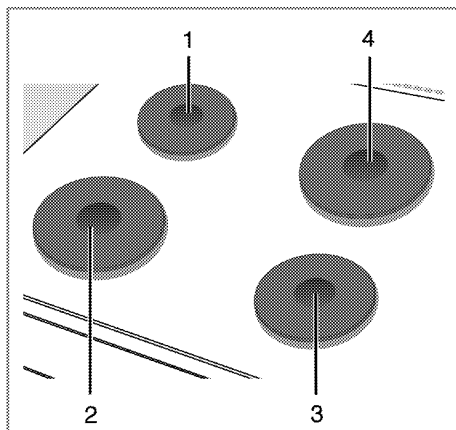

- 1 Hotplate 14-16 cm
- 2 Hotplate 18-20 cm
- 3 Hotplate 14-16 cm
- 4 Hotplate 18-20 cm is list of advised diameter of pots to be used on related burners.

How to use electrical hobs

The knobs for the hob can be rotated in either direction to provide fully variable heat control.

- i** Quick heating hotplates, if any, are marked with a red point.

Overheat protection

Plates of more than 1000 W burner power are equipped with overheating protection. The overheating protection reduces the burner power under the following conditions:

- No pot or pan on the plate.
- An empty pot or pan on the plate.
- Pot or pan bottom very uneven.

The plate is switched off when the position indicator is in the OFF (top) position.

Switching the plate on

The hob control knobs are used for operating the plates. To obtain the desired cooking power, turn the hob control knobs to the corresponding level.

Cooking level	1	2 – 3	4 – 6
	warming	stewing, simmering	cooking, roasting

Switching the plate off

Turn hob control knob to off position (top).

6 How to operate the oven

General information on baking, roasting and grilling

- ⚠ Risk of scalding by hot steam!
Take care when opening the oven door as steam may escape.

Tips for baking

- Use non-stick coated appropriate metal plates or aluminum containers or heat-resistant silicone moulds.
- Make best use of the space on the rack.
- It is recommended to place the baking mould in the middle of the rack.
- Select the correct shelf position before turning the oven or grill on - don't move oven shelves when hot.
- Keep the oven door closed.

Tips for roasting

- Seasoning with lemon juice and black pepper will improve the cooking performance when cooking a whole chicken, turkey or a large piece of meat.
- Meat with bones takes about 15 to 30 minutes longer before it is cooked than a roast of the same size without bones.
- You should calculate about 4 to 5 minutes cooking time per centimeter height of the meat.
- Let meat rest in the oven for about 10 minutes after the cooking time. The juice is better distributed all over the roast and does not run out when the meat is cut.

- Fish in a fire-resistant dish should be placed on the rack at the medium or lower level.

Tips for grilling

Grilling is ideal for cooking meat, fish and poultry and will achieve a nice brown surface without it drying out too much. Flat pieces, meat skewers and sausages are particularly suited for grilling as are vegetables with a high water content such as tomatoes and onions.

- Distribute the pieces to be grilled on the wire shelf.
- If the grilling is on the wire shelf, locate a dripping pan under it in order to collect the fat.
- Add some water in the dripping pan for easy cleaning.

How to use the electric oven

Select temperature and operating mode

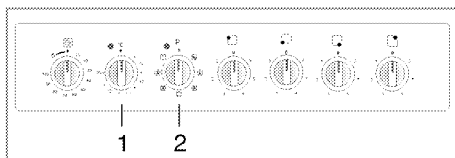

- 1 Thermostat knob
- 2 Function knob

The operating modes of the electric oven are selected with the function knob. The temperature is adjusted with the thermostat knob.

All oven functions are turned off by turning the relevant knob to off (upper) position.

1. Set the oven timer to the desired cooking time; see *How to operate the oven timer, page 18*.
2. Set thermostat knob to the desired temperature.
3. Set function knob to the required operating mode.

» The oven heats up to the adjusted temperature and maintains it. During heating, temperature lamp stays on.

Switch off electric oven

Switch the oven timer to off position.

-  When the timer is set to a certain time, it will turn off automatically; see *How to operate the oven timer, page 18*

Turn function knob and thermostat knob to off position (top).

Operating modes

The order of operating modes shown here might deviate from the arrangement on your appliance.

Top and bottom heat



Top and bottom heat are on. The foodstuffs are heated simultaneously from the upper and lower part. Suitable e.g. for cakes, cookies and casseroles in baking moulds. Cook with one tray only.

Top and bottom heat with convection air



Top and bottom heat plus fan (in the rear wall) are on. The hot air is distributed evenly and quickly all over the oven by the fan. Cook with one tray only.

Top heat and convection air



Top heat plus fan (in the rear wall) are on. Hot air is spread more evenly with the fan compared to only top heat.

Bottom heat and convection air



Bottom heat plus fan (in the rear wall) are on. Hot air is spread more evenly with the fan compared to only bottom heat.

Operating with fan



The oven is not heated. Only oven lamp plus fan (in the rear wall) are on. Frozen granular food is thawed slowly at room temperature and cooked food is cooled down.

Surface grill



The large grill (under the oven roof) is in operation. Suitable for grilling larger quantities.

- Put big or medium-sized portions in correct shelf position under the grill heater for grilling.
- Set the temperature to maximum level.
- Turn the food after half of the grilling time.

Grill with convection air



The grill effect is not as strong as with normal grilling.

- Put small or medium-sized portions in correct shelf position under the grill heater for grilling.
- Set the temperature to maximum level.
- Turn the food after half of the grilling time.

How to operate the oven timer

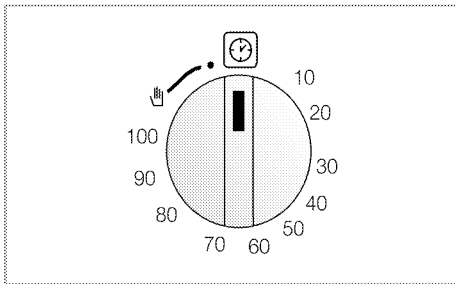

Starting cooking process

- To start heating units, adjust timer and set function knob to the required position. Otherwise, the oven will not operate.

1. Set cooking period by turning timer knob clockwise.
2. Put your dish into the oven.
3. Select operating mode and temperature; see *How to use the electric oven, page 16*.

» The oven will reach temperature and maintain this temperature until the end of the cooking time that has been selected.

4. Once the cooking time is over, time setting knob will automatically rotate counterclockwise. A warning sound indicating that the set time is over is heard and the power is cut.

- If you do not want to use timer function turn the knob counter-clockwise to the hand symbol.

5. Turn off the oven by using the time setting knob, function knob and/or temperature knob.

Interrupting the cooking process

1. Turn timer knob counterclockwise and finish the cooking process.
2. Turn off the oven using the function knob and/or temperature knob.









Cooking times table

- The values indicated in the table below are data indicative. They may vary according to the type of food as well as your preferences of cooking.

Baking and roasting

- Level 1 is the **bottom** level in the oven.

Food	Dish	Rack position		Temperature (°C)	Cooking time (min.) (approx.)	
Cake in tray	Baking tray 24 ... 26 cm	3	2	170 ... 180	25 ... 35	20 ... 30
Cake in mould	Cake mould 18 ... 22 cm	3	2	170 ... 180	35 ... 45	35 ... 45
Cookies	Baking tray	3	3	170 ... 190	25 ... 35	20 ... 25

Food	Dish	Rack position		Temperature (°C)	Cooking time (min.) (approx.)	
						
Flaky pastry	Baking tray
Brioche	Baking tray
Pies/pastries	Baking tray	3	3	 190 	40 ... 50	30 ... 40
Leaven	Roasting tray	3	3	 200 	35 ... 45	30 ... 35
Filled savory pastry	Baking tray	3	3	180 ... 190	25 ... 35	20 ... 30
Dough pastry	Baking tray	3	3	180 ... 190	40 ... 50	35 ... 45
Lasagne	Oven dish	3	3	170 ... 180	40 ... 50	35 ... 45
Pizza	Baking tray	3	3	200 ... 220	15 ... 20	15 ... 20
Roast beef	Casserole	3	3	15 min. 250/max *	110 ... 120	105 ... 115
Lamb shoulder	Casserole	3	3	15 min. 250/max *	70 ... 90	65 ... 85
Roast chicken	Casserole	3	3	15 min. 250/max *	60 ... 70	55 ... 65
Turkey (5.5 kg)	Baking tray	3	3	25 min. 220 *	180 ... 240	175 ... 230
Fish	Casserole	3	3	200	15 ... 25	10 ... 20

* then 150

How to operate the grill

-  Hot surfaces may cause burns!
Close oven door during grilling.
- **During grilling bring the timer knob to the hand sign by turning the counterclockwise.**

Switch on grill

1. Set the function knob onto the grill symbol.

Cooking times table for grilling

Grilling with electric grill

Food	Insertion level	Grilling time (approx.)
Fish	3...4	20...25 min. #
Sliced chicken	3...4	15...20 min.
Lamb chops	3...4	12...15 min.
Roast beef	3...4	15...25 min. #
Veal chops	3...4	15...25 min. #

depending on thickness

2. Set grill temperature.
 3. Preheat for approximately 5 minutes, if it is necessary.
- » The thermostat lamp is switched on.

Switch off grill

1. Turn grill control knob to off position (top).

7 Maintenance and care

General information

- ⚠ Risk of electric shock!
Switch off the electricity before cleaning appliance to avoid an electric shock.
- ⚠ Hot surfaces may cause burns!
Allow the appliance to cool down before you clean it.
- ⓘ The surface may get damaged by some detergents or cleaning materials.
Do not use aggressive detergents, cleaning powder/cream or any sharp objects.

Clean the appliance thoroughly after each use; in this way it will be possible to remove cooking residues more easily, thus avoiding these from burning the next time the appliance is used.

No special cleaning agents are required for cleaning the appliance. It is recommended to use warm water with washing liquid, a soft cloth or sponge and use a dry cloth for drying.

Do not use any abrasive cleaning materials!

- ⓘ Do not use steam cleaners for cleaning.

How to clean the hob

Electrical hobs

1. Switch plates off and let cool.
2. If necessary, treat plates with a cleaning agent (cleaner/conditioner available in selected stores).

3. Dry by switching on for a few minutes.
4. Apply a thin coat of cooking oil from time to time to provide a protective coating.

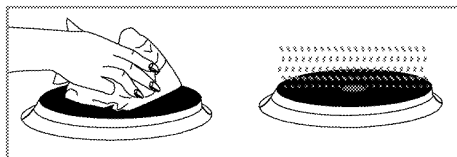

Cleaning the control panel

- ⓘ Damage of the control panel!
Do not remove the control knobs for control panel cleaning.

Clean control panel and control knobs.

Cleaning the oven

No oven cleaner or any other special cleaning agent is required for cleaning the oven. It is recommended to wipe the oven with a damp cloth while it is still warm.

Clean oven door

Don't use any harsh abrasive cleaners or sharp metal scrapers for cleaning the oven door. They could scratch the surface and destroy the glass.

Removal of oven door

The oven door can be disassembled for easier cleaning of the inner space of the oven.

1. Open oven door entirely.
2. Press hinged shackles back at both sides.

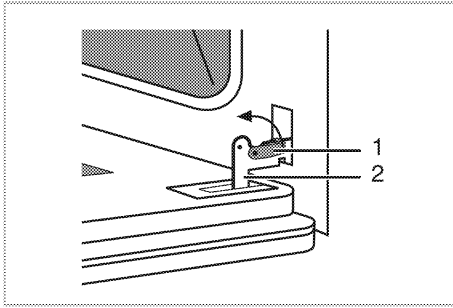

- 1 Hinged shackles
- 2 Hinge

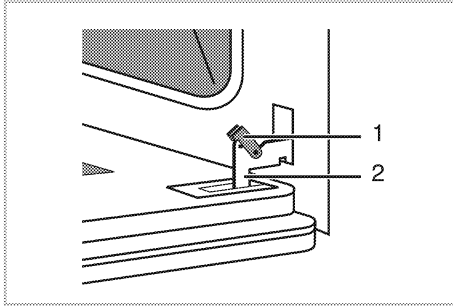

- 3. Put oven door in a slightly sloping position.
- 4. Lift the oven door to the front with both hands.

Install oven door again in reverse order after cleaning.

Replacing the oven lamp

- ⚠ Hot surfaces may cause burns!
Make sure that the appliance is switched off and cooled down in order to avoid the risk of an electrical shock.

The oven lamp is a special heat-resisting (T 300 °C) electric light bulb; see *Technical Data*, page 5. Oven lamps can be obtained from a good local electrical store.

- ℹ Position of lamp may vary from diagram.

1. Switch off the appliance at the mains.
2. Unscrew glass cover by turning anti-clockwise.

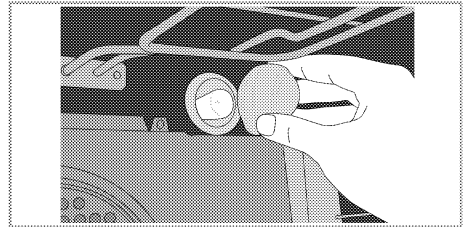

3. Unscrew oven lamp by turning anti-clockwise and replace it with new one.
4. Refit the glass cover.

8 Troubleshooting

-  Risk of electric shock, short circuit or fire by unprofessional repairs!
Repairs on the appliance must be carried out by an approved service centre.

- It is normal that steam escapes during operation.
- When the metal parts are heated, they may expand and cause noise.

Before you call the service, please check the following points.

Normal operating conditions

- Smoke and smell may emit for a couple of hours during the first operation.

Electrical equipment

Malfunction/problem	Possible cause	Advice/remedy
The appliance does not work.	The mains fuse is defective or has tripped.	Check fuses in the fuse box. If necessary, replace or reset them.
Oven light does not work	Oven lamp is defective.	Replace oven lamp.
	No current.	Check fuses in the fuse box. If necessary, replace or reset them.
Oven does not heat.	Function knob and/thermostat knob are not set.	Set function knob and thermostat knob.
	If the appliance has a timer, the timer may not be set.	Set the time.
	No power.	Check mains supply and fuse box.

Clock/ timer (If the appliance has a digital timer)

Malfunction/problem	Possible cause	Advice/remedy
Clock display is blinking or clock symbol is on.	Power was interrupted previously.	Set time Then switch the oven off with function knobs, set the oven function again.

If the problem has not been solved:

1. Separate unit from the mains supply (deactivate or unscrew fuse).
2. Call the after-sales service of your store reseller.

 Do not attempt to repair the appliance yourself. There are no customer service items inside the appliance.